



RoHS



## Scheda tecnica

|                    |             |
|--------------------|-------------|
| profondità         | 568 mm      |
| Altezza            | 686 mm      |
| Larghezza          | 702 mm      |
| Profondità interna | 480 mm      |
| Altezza interna    | 440 mm      |
| Larghezza interna  | 650 mm      |
| Livello di rumore  | 52 dB(A)    |
| KW/24h             | 2.9 Kw      |
| Capacità           | 120 L       |
| Consumo            | 230 W       |
| Peso               | 64 Kg       |
| Temperatura        | +1° ~ +12°C |

## Caratteristiche

- Espositore refrigerato da banco 120 Lt.
- Esterno di colore nero e inox
- Refrigerazione Ventilata
- Sbrinamento a fermata compressore
- Controllo con display digitale
- Luce interna LED
- Doppio vetro anti-condensazione
- Sportelli posteriori scorrevoli
- Ripiani regolabili cromati (N.2 ripiani)
- Basamento in acciaio inox

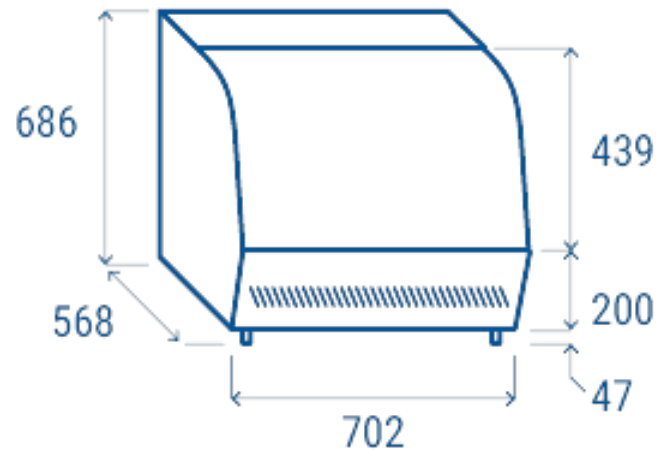

Vetri laterali e frontale curvi



Basamento in acciaio inox con controllore digitale



Luce LED interna